



MATTER WIRELESS ROOM THERMOSTAT

IT850



IT850TX
Wireless Thermostat

IT850RX
Border Receiver

SCAN FOR
MULTILANGUAGE
MANUAL



1. Introduction

The Matter Thermostat and Boiler Receiver combination provides seamless connectivity and efficient control of your home's heating and hot water systems.

The Boiler Receiver, acting as a border router, communicates with the thermostat via the Thread protocol and connects to the internet via Wi-Fi for remote access. The Receiver features a second relay for hot water control, ensuring comprehensive management of both systems.

This advanced setup ensures reliable performance and convenience, making it an ideal choice for modern smart homes.

2. Safety Information



Use in accordance with the regulations. Indoor use only. Keep your device completely dry.

For optimal performance and safety, the installation of the receiver and thermostat must be carried out by a qualified installer. Professional expertise ensures correct setup, safe connections, and compliance with all relevant regulations, helping to protect your equipment and guarantee reliable operation.

3. Product Compliance

This product is working at 2.4GHz and complies with the essential requirements and other relevant provisions of Directives 2014/53/EU and 2015/863/EU. The full text of the EU Declaration of Conformity is available at the following address: www.habismarthome.com/legal

4. Thermostat display & Buttons

1. RF Signal Indicator
2. Low Battery Indicator
3. Temperature display
4. Settings Indicator
5. Heating Indicator
6. Ring Knob
7. Locked Mode (Children Protection)
8. Off Mode (Frost Protection)
9. Press Button

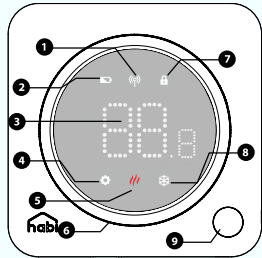

5. Receiver buttons & Functions

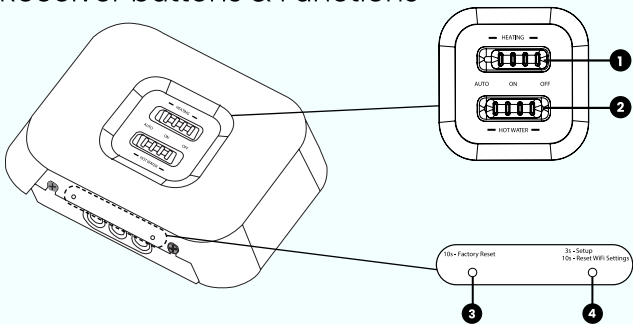

1. Central Heating slide switch
2. Domestic Hot Water switch
3. Factory Reset push button
4. Setup & WiFi Reset button

AUTO - Depending on the system output decision, Central Heating and/or Hot Water will be ON or OFF.

ON - Central Heating and/or Hot Water always ON.

OFF - Central Heating and/or Hot Water is turned OFF.

6. First setup

6.1 Powering up and mounting the Thermostat

1

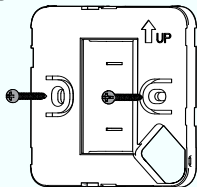

Make two holes in accordance with the position of the 2 screws.

2

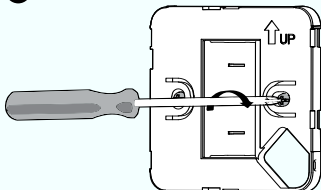

Tighten the screws in order to fix the wall mounting plate.

3

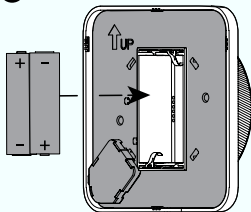

Insert the batteries (x2 AA alkaline) on the back of the thermostat.

4

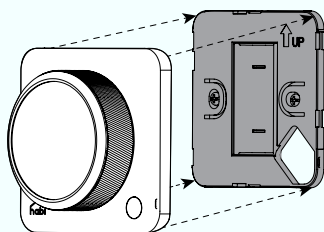

Fix the thermostat on the fixed wall mounting plate.

5

The device will power up once the batteries are put in place and after a few seconds the home screen will be shown.



6.2 Powering up and mounting the Receiver

To power up the receiver the following mounting procedure and the corresponding wiring diagrams must be followed for each case.

1

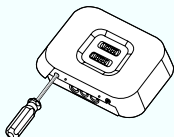

Loosen the screws on the underside of the receiver.

2

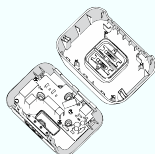

Remove the backplate from the front panel.

3

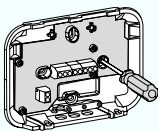

Fix the backplate to the wall following the direction as shown above.

4

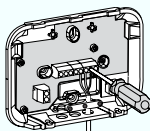

Wire up the backplate referring to one of the diagrams on the next pages.

5

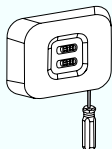

Put the front panel back onto the backplate by aligning the fittings and pushing it in place then securely fasten the screw.



Installation must be carried out by a qualified person in accordance to national and EU regulations.

Heating only - 230V switching

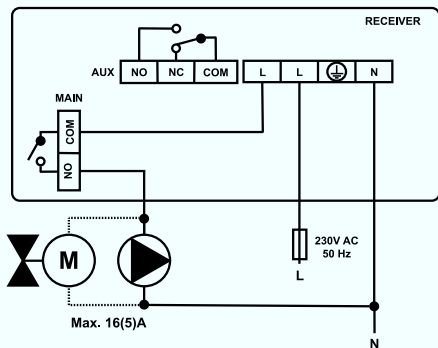

Heating only - volt-free output for Combi boiler 230V

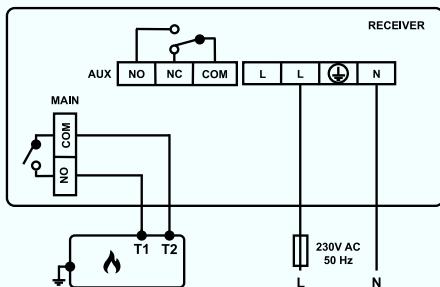

Heating and Domestic Hot Water - Y Plan 230V

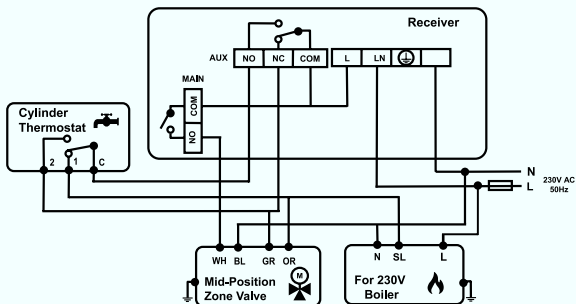

Heating and Domestic Hot Water - S Plan 230V

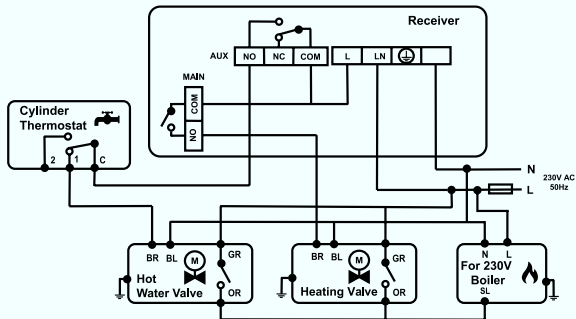

7. Pairing process

Once the receiver has been powered up, the pairing process can begin via the Habi App.

7.1 Install the App

This product must be used with the Habi application on mobile by accessing the following link:



7.2 Adding the Receiver

After installing the App and creating an account, the receiver is ready to be added.

1

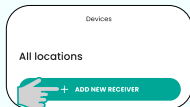

Select
Add New Receiver.

2



Select the discovered
receiver.

3

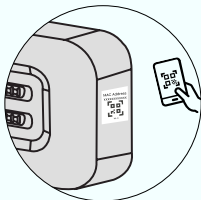
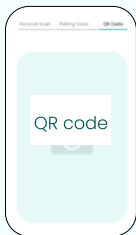

Scan the QR
code provided
on the side of
the receiver.

4



Select the network.

5

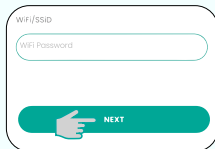

Add the WiFi Password and select **NEXT**.

6

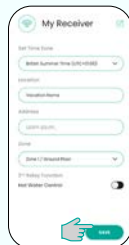

Add requested informations and select **Save** to finish.

7.3 Pairing of the Thermostat

1



From Devices menu select **ADD NEW DEVICE**.

2

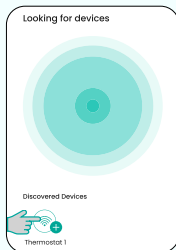

Select the found Thermostat.

3

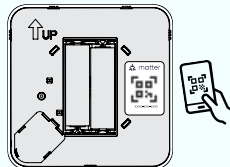

Scan the QR code provided on the back of the thermostat.

4

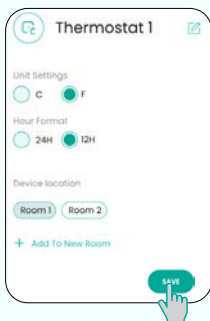

Save the Thermostat.

5

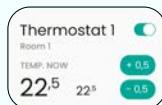

Thermostat has been paired and added to Devices page.

- ! After the installer removes their access from the system in the Habi app, the new owner can
- register the system by adding the Receiver to their account.

- ! **Thermostat:** The pairing mode on the thermostat will deactivate 5 minutes after being powered on. To reactivate, perform a power reset by reinserting the battery or performing a factory reset.

Receiver: The receiver's pairing mode will remain active for 15 minutes and can be reactivated using the Setup button located in the right pinhole.

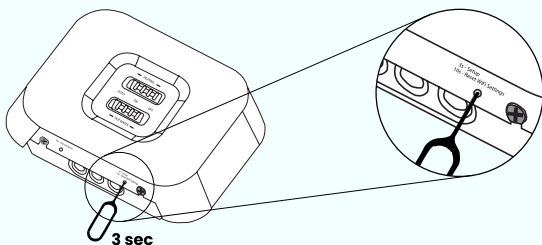



Units 8-10, Northfield Business
Park, Forge Way, Parkgate
Rotherham, S60 1SD
United Kingdom

Dieselstrasse 34,
63165 Mühlheim am Main,
Germany

www.habismarthome.com

Maintaining a policy of continuous product development HABI reserves the right to change specifications, design and materials of products listed in this brochure without prior notice.

